

# iTB403015



## External Dimensions (mm)

Height: 400  
Width: 300  
Depth: 150

## Construction Material

316L (1.4404), 304 (1.4301)  
Stainless Steel  
Mild Steel (CR4)

## Material Thickness (mm)

Body: 1.2 Lid: 1.2  
Gland Plate: 3.0  
Other thicknesses available

## Standard Finish

Stainless Steel - brushed  
Mild steel - Powder Coated  
Grey RAL7032 or RAL7035

## Optional Finish

Stainless steel - natural,  
pickled or electropolished  
Mild steel - customer specific  
colours and specification

## Door Fixing

Hinged door with bolts on  
opposite side. Through-lid  
padlock hasp optional

## Sealing Material

High performance  
silicone seal

## Enclosure Earth

M10 internal and external  
stainless steel earth stud  
assembly. Painted enclosures  
have M6 internal stud on  
door & painted gland plates

## Cable Entries

Via gland plates or  
direct through body

## Enclosure Mounting

Bolt directly to equipment  
or via 4 mounting lugs.  
These lugs are bolted  
on as standard but may  
be welded as an option.  
Other options available

## Enclosure Capacities

### Cable Entries

Size	Side			
	A Top	B Right	C Bottom	D Left
M16	18	24	18	20
M20	14	20	14	18
M25	5	8	5	7
M32	5	7	5	6
M40	4	6	4	5

(Gland plate entry capacity based upon regular pattern.  
More entries may be possible with staggered patterns.)

### Terminal Content

Conductor size	2.5 mm <sup>2</sup>	4 mm <sup>2</sup>	6 mm <sup>2</sup>	10 mm <sup>2</sup>
Quantity (vertical)	3x67	2x54	2x41	2x30

(Based on maximum physical content. Always check maximum cable bending radius.)

## Dimensions (mm)

A	B	C	D	E	F	G	H	I	J	K
400	300	150	360	340	200	300	78	256	356	298

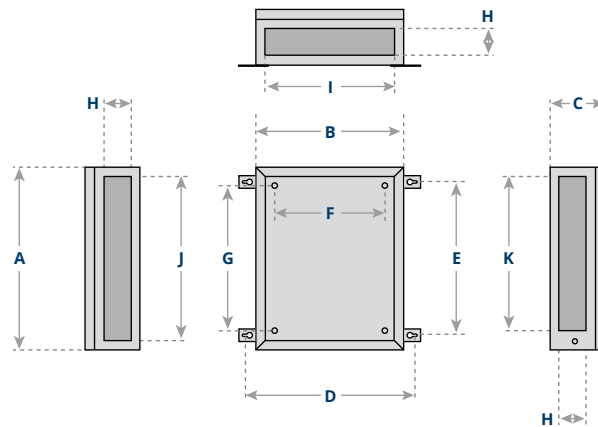

## Certificates

### Component (ATEX) (IECEX)

Certificate No.	SIRA11ATEX3142U IECEX SIR 120083U Iss4
Service Temperature Range	-40°C to +135°C
Ingress Protection	IP66
Impact Resistance	7J Nm

### Apparatus (ATEX) (IECEX)

Certificate No.	SIRA11ATEX3241X IECEX SIR 15.0002X Iss 0
Marking	II 2 GD
Protection Concepts	GAS: Ex e IIC Gb T6, T5, T4 DUST: Ex tb IIIC Db IP66
Ambient Temperature	Min -50°C Max +70°C

## Part Number Selection Example

Order code: iTB S1 40 30 15 2 AC

Family	Material	Height	Width	Depth	No. of Gland Plates	Gland Plate Faces
iTB	S1	40	30	15	2	AC
iTB	316L	400mm	300mm	150mm	2	Top, Bottom
	S1 = 316L S2 = 304 PS = Mild Steel				0,1,2,3 or 4	A = Top B = Right C = Bottom D = Left