

iTB404015



External Dimensions (mm)

Height: 400
Width: 400
Depth: 150

Construction Material

316L (1.4404), 304 (1.4301)
Stainless Steel
Mild Steel (CR4)

Material Thickness (mm)

Body: 1.2 Lid: 1.2
Gland Plate: 3.0
Other thicknesses available

Standard Finish

Stainless Steel - brushed
Mild steel - Powder Coated
Grey RAL7032 or RAL7035

Optional Finish

Stainless steel - natural,
pickled or electropolished
Mild steel - customer specific
colours and specification

Door Fixing

Hinged door with bolts on
opposite side. Through-lid
padlock hasp optional

Sealing Material

High performance
silicone seal

Enclosure Earth

M10 internal and external
stainless steel earth stud
assembly. Painted enclosures
have M6 internal stud on
door & painted gland plates

Cable Entries

Via gland plates or
direct through body

Enclosure Mounting

Bolt directly to equipment
or via 4 mounting lugs.
These lugs are bolted
on as standard but may
be welded as an option.
Other options available

Enclosure Capacities

Cable Entries

Size	Side			
	A Top	B Right	C Bottom	D Left
M16	24	24	24	20
M20	20	20	20	18
M25	8	8	8	7
M32	7	7	7	6
M40	6	6	6	5

(Gland plate entry capacity based upon regular pattern.
More entries may be possible with staggered patterns.)

Terminal Content

Conductor size	2.5 mm ²	4 mm ²	6 mm ²	10 mm ²
Quantity (vertical)	4x67	3x54	3x41	3x30

(Based on maximum physical content. Always check maximum cable bending radius.)

Dimensions (mm)

A	B	C	D	E	F	G	H	I	J	K
400	400	150	460	340	300	300	78	356	356	298

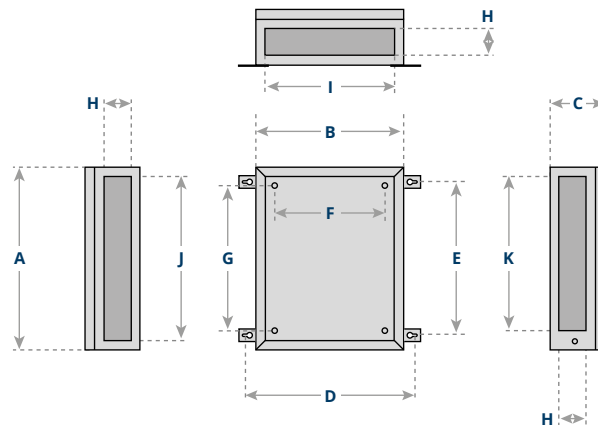

Certificates

Component (ATEX) (IECEx)

Certificate No.	SIRA11ATEX3142U IECEx SIR 120083U Iss4
Service Temperature Range	-40 °C to +135 °C
Ingress Protection	IP66
Impact Resistance	7J Nm

Apparatus (ATEX) (IECEx)

Certificate No.	SIRA11ATEX3241X IECEx SIR 15.0002X Iss 0
Marking	II 2 GD
Protection Concepts	GAS: Ex e IIC Gb T6, T5, T4 DUST: Ex tb IIIC Db IP66
Ambient Temperature	Min -50°C Max +70°C

Part Number Selection Example

Family	Material	Height	Width	Depth	No. of Gland Plates	Gland Plate Faces
iTB	S1	40	40	15	2	AC
iTB	316L	400mm	400mm	150mm	2	Top, Bottom
	S1 = 316L S2 = 304 PS = Mild Steel				0,1,2,3 or 4	A = Top B = Right C = Bottom D = Left